

# 6

essential  
equipment

To

improve  
ergonomics in  
collective  
catering

**03** — *Observation - Some figures*

**04** — *The 6 essential pieces of equipment*

**06** — *Zoom on*

the stainless steel lifter  
**HAPPYLIFT**

**10** — *Zoom in on*

the height-adjustable tank  
**HAPPYCUVAMO**

**12** — *Zoom in on*

the height adjustable stainless steel troughs  
**HAPPYPAT**

**14** — *Zoom in on*

the rising-bottom soaking tank  
**HAPPYWASH**

**16** — *Zoom in on*

the stainless steel height-adjustable work table  
**HAPPYWORK**

**18** — *Zoom in on*

stainless steel roller conveyors  
**HAPPYCONDI**

**20** — Designed, assembled and manufactured close to you

**21** — They trust us



# CATERING PERSONEL ARE OFTEN IMPACTED BY MUSCULOSKELETAL DISORDERS

(Musculoskeletal Disorders)

DID YOU KNOW



**+98%**

occupational diseases in the food industry are linked to MSDs.

**+53%**

sick leave is related to manual handling injuries.

**€4.4 billion**

cost for companies, i.e. 33% of all contributions received by occupational risk health insurance for Work Accidents/Occupational Illnesses.

Manual handling is the leading cause of work accidents.

\*French figures

*Together, let's find solutions to improve your workstations by eliminating manual handling.*

Source: CARSAT/CRAMIF claims sheet for 2021

On gagne tous  
au **meilleu**r-être  
au travail.





*Stainless steel roller  
conveyors*  
**HAPPYCONDI**  
p.18



*Height-  
adjustable containers*  
**HAPPYCUVAMO**  
p.10

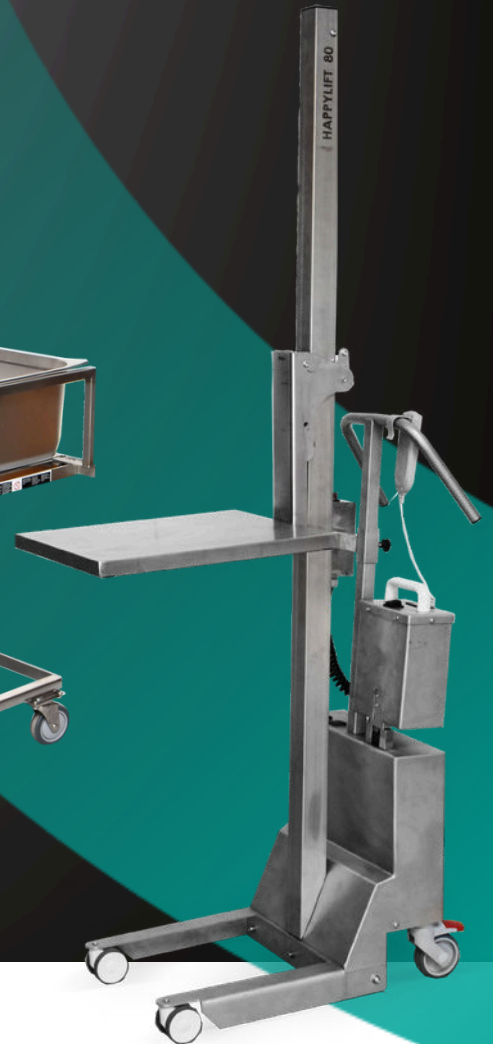

*Stainless steel lifter*  
**HAPPYLIFT**  
p.6

*the 6 essential  
equipment*

# THE 6 ESSENTIAL PIECES OF EQUIPMENT

*in collective catering*

After several years of working with our clients in the professional kitchen sector, we have been able to define 6 "flagship" and, above all, essential products to integrate to improve their workstations.



**Ajustable height stainless  
steel troughs  
HAPPYPAT**

*p.12*

**Stainless steel height-  
adjustable work table  
HAPPYWORK**

*p.16*

**Rising-bottom  
soaking tank  
HAPPYWASH**

*p.14*



zoom in on

# STAINLESS STEEL MINI LIFTER HAPPYLIFT

*Electric or manual*

To eliminate the need to carry loads and prevent musculoskeletal disorders (MSDs) for your employees, the HAPPYLIFT stainless steel electric lifter allows you to handle all types of containers without difficulty.

Made of stainless steel, the HAPPYLIFT can lift, move and handle loads ranging from 100 kg to 300 kg.



AISI304  
stainless steel  
construction



Capacities  
from 100  
to 300 kg



H3m  
max  
From 0 to  
3 meters

*Its greatest quality:*  
**Versatility**

The accessories are all interchangeable which are attached to the moving carriage on the mast.

Different interchangeable tools

Different bases

Different mast heights



Download the  
**HAPPYLIFT**  
standard sheets  
from our website



Model presented:  
Ref Happylift :  
LIFT100ML2



Model presented :  
Réf Happylift :  
LIFT100ML1

Stainless steel  
platform  
accessory  
Ref: OPTLIF1001

## TOOL. 1

### Stainless steel single platform

*For all types of loads : the simple stainless steel platform allows you to handle your loads simply and effortlessly.*



Discover the video



Model presented:  
Ref Happylift :  
LIFT100SL3  
& OPTLIFT1035  
& OPTLIFT1015

## TOOL. 2

### Forks for crate dollies

*Packaging : the fork accessory for mobile crate dollies along with the constant level option allows the operator to have automatic leveling of the crates.*



Discover the video





Model presented:  
Happylift Ref: [LIFT100ML2](#)  
GN container tilting  
accessory Ref: [OPTLIF1022](#)

### TOOL. 3

## GN container tipper

**In production:** the accessory for tipping a GN container over pots and pans. No need for two people to lift and tip the container!



Discover the video



Model presented:  
Happylift Ref: [LIFT100ML2](#)  
Gripping fork accessory  
Ref: [OPTLIFT1016](#)

### TOOL. 4

## Grab fork with cleats for bins

**In batch preparation:** the gripping fork accessory with cleats allows you to pick up crates/bins without rolling bases to load them into insulated containers.



Discover the video





Model presented:  
Happylift  
Ref: LIFT100ML1  
Stainless steel  
platform accessory  
Ref: OPTLIF1008

TOOL. 5

## Stainless steel platform with with GN container safety device

**In production:** the GN container accessory facilitates handling, such as correct height for entering into an oven or stacking on a tray trolley.



Discover the video



## HAPPYLIFT200 & 300

Capacity 200 or 300 kg

## Fork for stainless steel rolling base

**Packaging:** this accessory automatically adjusts a stack of stainless steel GN containers thanks to its constant level sensor.



Discover the video



HAPPYMANUT stainless steel rolling base compatible with:  
Ref. : 11980003

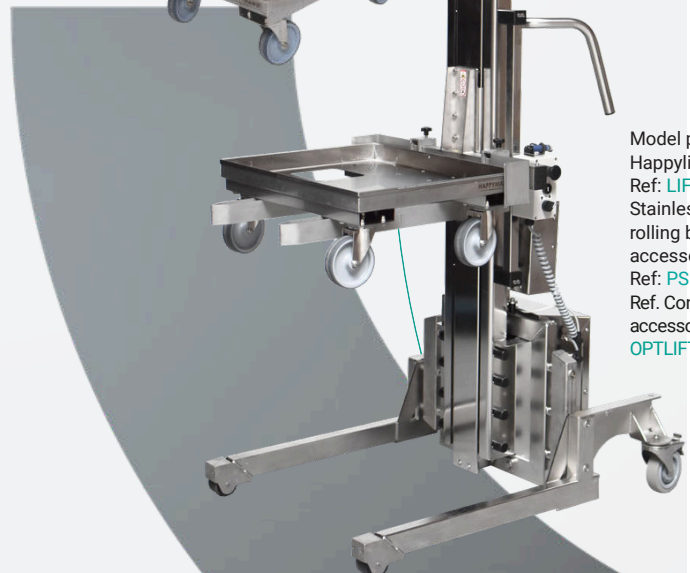

Model presented:  
Happylift  
Ref: LIFT200ML1  
Stainless steel rolling base fork accessory  
Ref: PSM  
Ref. Constant level accessory:  
OPTLIFT2338



*zoom in on*

# VARIABLE TROLLEY FOR GN CONTAINERS HAPPYCUVAMO

## *Adjustable height*

*The HappyCuvamo is a mobile GN container carrier with variable level, designed to facilitate the safe transport of heavy, liquid or delicate objects.*

*Thanks to its robust stainless steel construction, it reduces strain, improves the ergonomics of workstations and protects your teams.*

*Specially designed for GN 1/1 and GN 2/1 stainless steel containers, it ensures stable, smooth and secure transport.*

AISI  
304

AISI304  
stainless steel  
construction



Capacity up  
to 100kg



Hygienic (easily cleaned  
with plenty of water)



Download the  
**HAPPYCUVAMO**  
standard sheets from  
our website

Model presented:  
Ref : CUVAMO100

EXAMPLE. 1

## Emptying under your vegetable cutters

Effortless filling and leveling of the stainless steel GN container.



Discover the video 

EXAMPLE. 2

## In packaging

Lifting your GN containers to a suitable working level in a packaging line.



Discover the video 

EXAMPLE. 3

## Emptying under your pots/saute pans

**In production:** With its foot pedal, nothing could be simpler for raising or lowering the tray under your pots and pans.



Discover the video 





*zoom in on*

# ADJUSTABLE STAINLESS STEEL TROUGH HAPPYPAT

## *Adjustable height*

The height adjustable mobile trough, available in 100L and 200L versions, makes it easy to transfer ingredients or mixtures to a suitable height. It replaces the standard half-cylindrical tank, which is not always suitable for all employees on a daily basis.



AISI304  
stainless steel  
construction



Equipped  
with a drain  
valve



Hygienic (easily  
cleanable with  
plenty of water)



Download the  
**HAPPYPAT**  
standard sheets  
from our website

Model presented:  
Ref: PATH200

EXAMPLE. 1

## Mixture of foodstuffs

**In production:** The semi-cylindrical shape of the product provides comfort, making it easy to grip while always remaining in the center of the tank.



Discover the video 



Available in 100L or 200L model depending on your needs!



EXAMPLE. 2

## Emptying under your mixers

After mixing, emptying the mixing bowl is an easy task with the adjustable height facility.



Discover the video 





zoom in on

# RISING-BOTTOM SOAKING TANK HAPPYWASH

## *Full tilt*

The HappyWash tank with a height adjustable tray/basket is ergonomically designed to make dishwashing easier. It allows you to soak dishes once you have placed them into the ingenious basket system and lowered it to the tank. This device eliminates bending, reducing physical effort and making cleaning more comfortable. By choosing the HappyWash sink, you not only improve your efficiency, but also protect your back from unnecessary strain.



AISI304  
stainless steel  
construction



Equipped  
with a drain  
valve



300 kg  
max From 100  
to 300 kg



Download the  
**HAPPYWASH**  
standard sheets  
from our website

Model presented:  
Ref: WASH300

Model presented:  
Ref: WASH100



#### EXAMPLE. 1

## Suitable for dishwasher baskets

**At the self-service restaurant:** Specially dedicated to soaking dishwasher baskets and cutlery to allow them to be retrieved at the correct height.

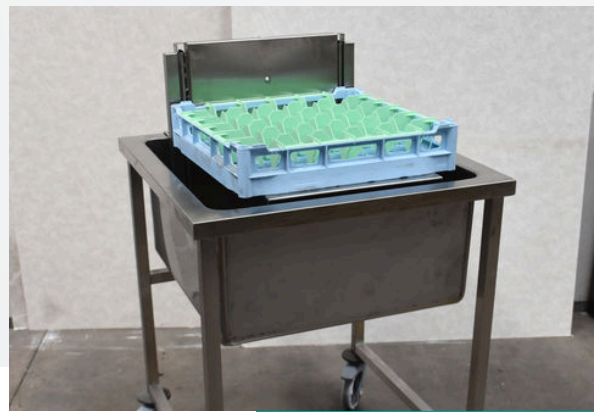

Discover the video 

Model presented:  
Ref: WASH300



#### EXAMPLE. 2

## Stainless steel soaking tank

**In the kitchen:** Soak all types of dishes and utensils (GN container or others) with the height adjustable basket in the interior without having to bend down.



Discover the video 



zoom in on

# STAINLESS STEEL TABLES HAPPYWORK

## Height adjustable

Our range of height-adjustable tables are sturdy, hygienic and ideal for demanding environments such as the food industry or laboratories.

It is manually height-adjustable, allowing it to be adapted to each user for optimal comfort and improved ergonomics. Multiple dimensions are available to meet your expectations as closely as possible.



AISI 304  
stainless steel  
construction



Manual or  
electric



Adjustable  
from 600/700  
to 1000 mm



Download the  
standard sheets for  
the **HAPPYWORK**  
range on our website



EXAMPLE. 1

## Electric model : HAPPYWORKPLAN

*In production :* The height-adjustable electric trolley is ideal for working at the right height thanks to its remote control.



Discover the video



EXAMPLE. 2

## Manual model : HAPPYWORKTABLE

*Packaging :* The manual variable height table is perfect for adjusting to the height of your choice thanks to its folding crank.



Discover the video





*zoom in on*

# STAINLESS STEEL ROLLER CONVEYORS HAPPYCONDI

*Height adjustable*

*Our range of packaging equipment has been developed in close collaboration with our customers' needs. From solutions for working at height to presses for lids for various containers, this equipment is designed to offer optimal working comfort.*



AISI 304  
stainless  
steel  
construction



Folding crank  
control



Adjustable  
from 700 to  
1000 mm



Download the  
standard range sheets  
**HAPPYCONDI**  
on our website

EXAMPLE. 1

## Conditioning table **HAPPYCONDITABLE**

An ergonomic work table with adjustable and customizable height, designed for the secure packaging of reusable containers in collective catering (stainless steel GN containers, etc.).



Discover the video

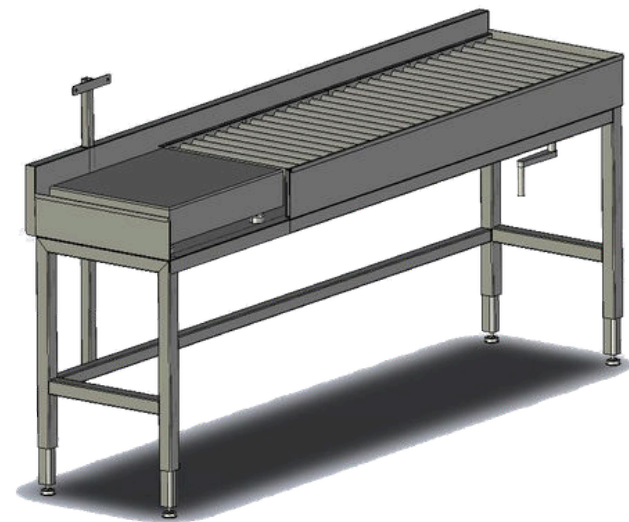

EXAMPLE. 2

## Lid press **HAPPYCONDIPRESSE**

This lid press system is a machine specially designed to close different types of containers with great ease.

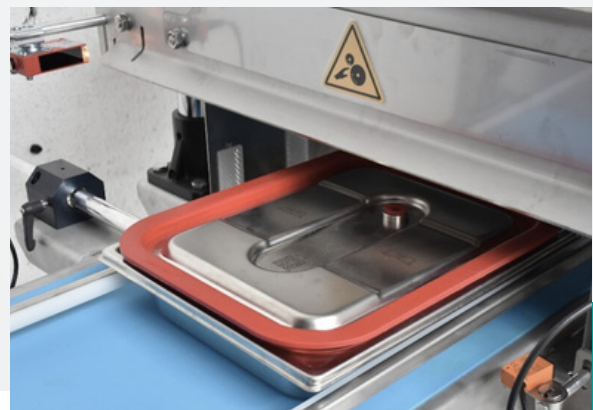

Discover the video



# Why choose *Happymanut* ?

Choosing our solutions means opting for a virtuous circle where each asset reinforces the next :



High-quality,  
perfectly adapted  
stainless steel  
equipment.



Measurable  
increase in your  
productivity.



Promoting your  
employer brand.



Increased  
employee  
satisfaction.



Reduction of  
work accidents  
and associated  
absences.

We all thrive at work  
through  **uplifted well-being.**

# Our references *in collective catering*

Discover some of the companies that trust us:



We all thrive at work through **uplifted well-being.**

# OUR CUSTOMERS SPEAK ABOUT IT BEST!

## Collective catering

Congratulations on what you are doing to improve ergonomics and make our employees' work easier. Companies never invest enough to improve their employees' working conditions!



**Jean-Christophe LESAVRE**  
Director of Engineering at  
SODEXO (formerly)

**Very good equipment  
which is unanimously  
approved in production.**

**Nolwenn Beauverger**  
Deputy Director GIP  
SILGOM



The 200 kg stainless steel HAPPYPAT200 are essential to protect the backs of our employees, who do a fantastic job. As an employer in Dijon Métropole, the health and safety of our employees is a priority.

**Stéphane DE LAZZER**  
Vegetable Director,  
Central Kitchen, Dijon  
Métropole



**HAPPYCUVAMO  
SILGOM**



The equipment offered fully addresses the major challenges of the MSD industry. The manufacturing is high-quality, as is the reliability. A large proportion of the kitchen staff are currently satisfied with the equipment that HAPPYMANUT has provided us.



**David DAILLON,**  
Director of SIVU  
COCLICO

When it comes to ergonomics in school catering, the biggest challenge lies in prevention. Corrective ergonomics still needs to be strengthened, and HAPPYMANUT is supporting us by offering innovative equipment that allows for better adaptation to work for many employees, some of whom have multiple medical restrictions. It also ensures fair treatment for the distribution of tasks.



**Hardware solutions related to the prevention of MSDs are very efficient and meet the expectations of users who find comfort in their work and a reduction in physical stress.**

**Michel LAURENT,**  
Catering Coordinator,  
Lyon Metropolis



**Stéphane JEDAR**  
Technical advisor for the  
Auvergne Rhône Alpes region

We all thrive at work  
through **Uplifted**  
**well-being.**



8, rue de Malacussy  
42100 Saint-Etienne  
Phone : +33 (0)477 798 891  
[www.happymanut.net](http://www.happymanut.net)

**HappyManut**  
ergonomic solutions